

RGE Selection Guide and Product Data

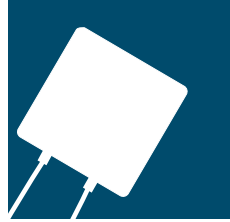

This section has two parts:

- **A Selection Guide that walks you through the process of selecting the correct RGE device for a circuit.**
- **Product Data that outlines electrical characteristics, physical characteristics, agency recognitions, environmental specifications, component layouts, tape and reel specifications, and ordering information for RGE devices.**

RGE Selection Guide

Follow these seven steps to select a PolySwitch RGE device for a circuit:

1. Define the operating parameters for the circuit.
These include:
 - Maximum ambient operating temperature
 - Normal operating current
 - Maximum operating voltage (RGE is 16 V maximum)
 - Maximum interrupt current
2. Select the RGE device that accommodates the circuit's maximum ambient operating temperature and normal operating current.
3. Compare the RGE device's maximum operating voltage and maximum interrupt current with the circuit's to be sure the circuit does not exceed the device ratings.
4. Check the RGE device's time-to-trip to be sure it will protect the circuit.
5. Verify that the circuit's ambient operating temperatures are within the RGE device's operating temperature range.
6. Verify that the RGE device's dimensions fit the application's space considerations.
7. Independently evaluate and test the suitability and performance of the RGE device in the application.

4



1. Define the circuit's operating parameters.

Fill in the following information about the circuit:

Maximum ambient operating temperature _____

Normal operating current _____

Maximum operating voltage (RGE is 16 V max.) _____

Maximum interrupt current _____

2. Select the PolySwitch RGE device that will accommodate the circuit's maximum ambient operating temperature and normal operating current.

Look across the top of the table below to find the temperature that most closely matches the circuit's maximum ambient operating temperature. Look down that column to find the value equal to or greater than the circuit's normal operating current. Now look to the far left of that row to find the part number for the RGE device that will best accommodate the circuit.

The thermal derating curve located on the next page is a normalized representation of the data in the table below.

I_{Hold} vs. temperature

Part number	Maximum ambient operating temperatures (°C)									
	-40°	-20°	0°	20°	25°	40°	50°	60°	70°	85°
RGE300	4.4	4.0	3.6	3.1	3.0	2.6	2.4	2.1	1.9	1.4
New RGE400	5.9	5.3	4.8	4.1	4.0	3.5	3.2	2.8	2.5	1.9
RGE500	7.3	6.6	6.0	5.2	5.0	4.4	4.0	3.6	3.1	2.4
New RGE600	8.8	8.0	7.2	6.2	6.0	5.2	4.8	4.2	3.8	2.8
RGE700	10.3	9.3	8.4	7.3	7.0	6.2	5.6	5.0	4.4	3.3
New RGE800	11.7	10.7	9.6	8.3	8.0	6.9	6.4	5.6	5.1	3.7
RGE900	13.2	11.9	10.7	9.4	9.0	7.9	7.2	6.4	5.6	4.2
New RGE1000	14.7	13.3	12.0	10.3	10.0	8.7	8.0	7.0	6.3	4.7
RGE1100	16.1	14.6	13.1	11.5	11.0	9.7	8.8	7.8	6.9	5.2
New RGE1200	17.6	16.0	14.4	12.4	12.0	10.4	9.6	8.4	7.6	5.6
New RGE1400	20.5	18.7	16.8	14.5	14.0	12.1	11.2	9.8	8.9	6.5

Thermal derating curve

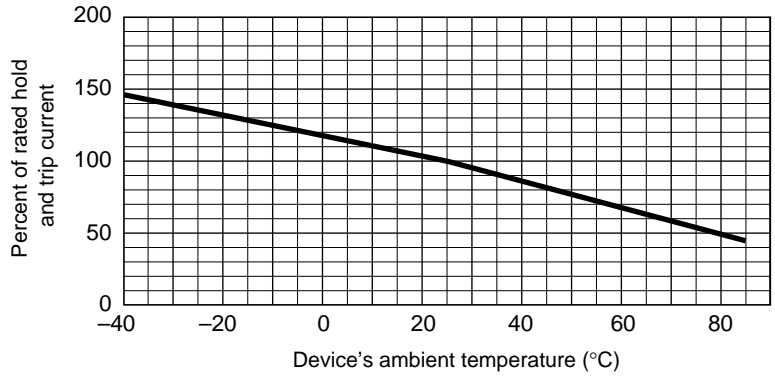

3. Compare maximum operating voltages and maximum interrupt currents.

Look down the first column of the table below to find the part number you selected in Step 1. Look to the right in that row to find the device's maximum operating voltage (V max.) and maximum interrupt current (I max.).

Compare both ratings with the circuit's to be sure the circuit's ratings do not exceed those of the RGE device.



Maximum device voltages and currents*

Part number	V max. (volts)	I max. (amps)
RGE300	16	100
New RGE400	16	100
RGE500	16	100
New RGE600	16	100
RGE700	16	100
New RGE800	16	100
RGE900	16	100
New RGE1000	16	100
RGE1100	16	100
New RGE1200	16	100
New RGE1400	16	100

*Device may withstand higher interrupt current at lower voltages. Each application will need to be individually qualified.

4. Determine time-to-trip.

Time-to-trip is the amount of time it takes for a device to switch to a high-resistance state once a fault current has been applied across the device.

Identifying the RGE device's time-to-trip is important in order to provide the desired protection capabilities. If the device you choose trips too fast, undesired or nuisance tripping will occur. If the device trips too slowly, the components being protected may be damaged before the device switches to a high-resistance state.

The chart below shows the typical time-to-trip at 25°C for each PolySwitch RGE device. For example, the chart indicates that the typical time-to-trip for RGE500 at 10 A is 10 seconds.

On the chart below, find the typical time-to-trip for the RGE device you selected. If the RGE device's time-to-trip is too fast or too slow for the circuit, go back to Step 2 and choose an alternate device.

Typical time-to-trip at 25°C

4

- A = RGE300
- B = RGE400
- C = RGE500
- D = RGE600
- E = RGE700
- F = RGE800
- G = RGE900
- H = RGE1000
- I = RGE1100
- J = RGE1200
- K = RGE1400

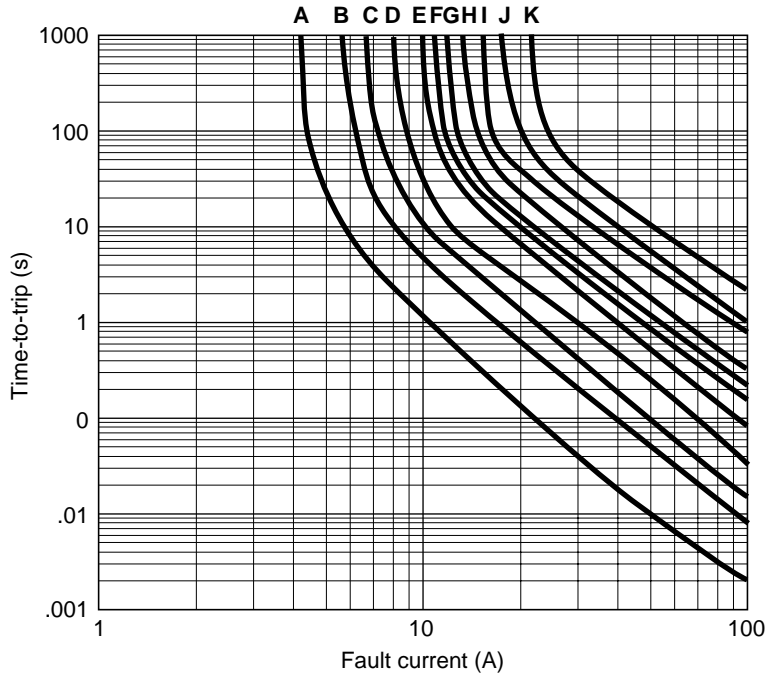

5. Verify ambient operating conditions.

Ensure that your application's minimum and maximum ambient temperatures are within the operating temperature range of -40°C and 85°C .

Maximum device surface temperature in the tripped state is 125°C .

6. Verify the RGE device's dimensions.

Using dimensions from the table below, compare the dimensions of the RGE device you selected with the application's space considerations.

Product dimensions (millimeters/inches)

Part number	A max.	B max.	C typ.	D min.	E max.	F typ.
RGE300	7.1 (0.28)	11.0 (0.43)	5.1 (0.20)	7.6 (0.30)	3.0 (0.12)	1.2 (0.05)
New RGE400	8.9 (0.35)	12.8 (0.50)	5.1 (0.20)	7.6 (0.30)	3.0 (0.12)	1.2 (0.05)
RGE500	10.4 (0.41)	14.3 (0.56)	5.1 (0.20)	7.6 (0.30)	3.0 (0.12)	1.2 (0.05)
New RGE600	10.7 (0.42)	17.1 (0.67)	5.1 (0.20)	7.6 (0.30)	3.0 (0.12)	1.2 (0.05)
RGE700	11.2 (0.44)	19.7 (0.78)	5.1 (0.20)	7.6 (0.30)	3.0 (0.12)	1.2 (0.05)
New RGE800	12.7 (0.50)	20.9 (0.82)	5.1 (0.20)	7.6 (0.30)	3.0 (0.12)	1.2 (0.05)
RGE900	14.0 (0.55)	21.7 (0.85)	5.1 (0.20)	7.6 (0.30)	3.0 (0.12)	1.2 (0.05)
New RGE1000	16.5 (0.65)	24.1 (0.95)	5.2 (0.20)	7.6 (0.30)	3.0 (0.12)	1.2 (0.05)
RGE1100	17.5 (0.69)	26.0 (1.02)	5.1 (0.20)	7.6 (0.30)	3.0 (0.12)	1.2 (0.05)
New RGE1200	17.5 (0.69)	28.0 (1.10)	10.2 (0.40)	7.6 (0.30)	3.6 (0.14)	1.4 (0.06)
New RGE1400	27.9 (1.10)	27.9 (1.10)	10.2 (0.40)	7.6 (0.30)	3.4 (0.13)	1.4 (0.06)

4

RGE300–RGE1400*

Lead Size

RGE300–RGE1100
 \varnothing 0.81
 (0.032)
 20 AWG

RGE1200–RGE1400
 \varnothing 1.0
 (0.040)
 18 AWG

* Kinked leads are available for RGE300 - RGE1400

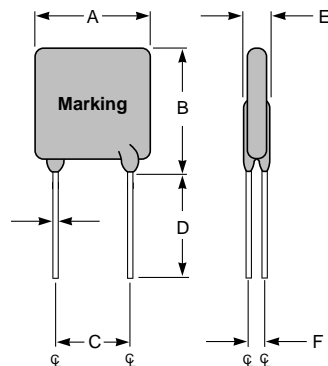

RGE Product Data

Now that you have selected your RGE device, please review the device's characteristics in this section to verify that the device will perform as required.

Electrical characteristics (25°C)

Part Number	I _H (A)	I _T (A)	Max. time to trip (s) at 5xI _H	P _d (W)	Initial resistance R min. (Ω)	Post-trip resistance R ₁ max. (Ω)
RGE300	3.0	5.1	2.0	2.3	0.034	0.105
New RGE400	4.0	6.8	3.5	2.4	0.020	0.063
RGE500	5.0	8.5	3.6	2.6	0.014	0.044
New RGE600	6.0	10.2	5.8	2.8	0.009	0.030
RGE700	7.0	11.9	8.0	3.0	0.006	0.021
New RGE800	8.0	13.6	9.0	3.0	0.005	0.018
RGE900	9.0	15.3	12.0	3.3	0.004	0.015
New RGE1000	10.0	17.0	12.5	3.3	0.003	0.012
RGE1100	11.0	18.7	13.5*	3.7	0.003	0.010
New RGE1200	12.0	20.4	16.0	4.2	0.002	0.009
New RGE1400	14.0	23.8	20.0	4.6	0.002	0.008

I_H = Hold current—maximum current at which the device will not trip at 25°C.

I_T = Trip current—minimum current at which the device will always trip at 25°C.

P_d = Typical power dissipation—typical amount of power dissipated by the device when in tripped state in 25°C still air.

R min. = Minimum device resistance at 25°C prior to tripping.

R max. = Maximum device resistance at 25°C prior to tripping.

R₁ max. = Maximum device resistance at 25°C measured 1 hour post trip.

* Device tested at 60 A.

Physical characteristics

Lead material	RGE300—RGE1100: Tin lead-plated copper, 20 AWG, Ø 0.81 mm/0.032 in RGE1200—RGE1400: Tin lead-plated copper, 18AWG, Ø 1.0 mm/0.04 in
Soldering characteristics	Solderability per ANSI/J-STD-002 Solder heat withstand per IEC 68-2-20: RGE300, Test Tb; should be soldered to the printed circuit in less than 4 seconds at maximum temperature of 260°C ± 5°. RGE500—RGE1400, Test Tb; can withstand 10 seconds at 260°C ± 5°.
Insulating material	Cured, flame-retardant epoxy polymer; meets UL 94V-0 requirements Note: Devices are not designed to be placed through a reflow process.

Agency recognitions

CSA	File # CA 78165C
TÜV	Certificate # R9677540
UL	File # E74889

Environmental specifications

Test	Test method	Conditions	Resistance change
Passive aging	Raychem PS300	-40°C, 1000 hours	±5%
		85°C, 1000 hours	±5%
Humidity aging	Raychem PS300	85°C, 85% R.H., 1000 hours	±5%
Thermal shock	Raychem PS300	85°C, -40°C (10 times)	±5%
Solvent resistance	Raychem PS300, Method 215	MIL-STD-202, Method 215F	No change

Component layouts

The dimensions in the table below provide the component layout for each RGE device.

Component layout dimensions (millimeters/inches)

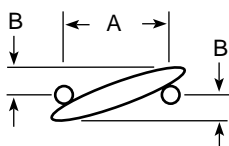

Device	A nom.	B max.
RGE300	5.1 (0.20)	1.2 (0.05)
New RGE400	5.1 (0.20)	1.4 (0.06)
RGE500	5.1 (0.20)	1.6 (0.06)
New RGE600	5.1 (0.20)	1.6 (0.06)
RGE700	5.1 (0.20)	1.7 (0.07)
New RGE800	5.1 (0.20)	1.8 (0.07)
RGE900	5.1 (0.20)	2.0 (0.08)
New RGE1000	5.1 (0.20)	2.0 (0.08)
RGE1100	5.1 (0.20)	2.4 (0.09)
New RGE1200	10.2 (0.40)	1.5 (0.06)
New RGE1400	10.2 (0.40)	1.9 (0.07)



RGE tape and reel specifications (dimensions in millimeters)

Product availability: RGE300–RGE700 (consult factory for higher hold current parts).

Devices taped using EIA468-B/IEC286-2 standards. See table below and Figures 1 and 2 for details.

Dimension description	EIA mark	IEC mark	Dimensions	
			Dim. (mm)	Tol. (mm)
Carrier tape width	W	W	18	–0.5/+1.0
Hold down tape width	W_4	W_0	11	min.
Top distance between tape edges	W_6	W_2	3	max.
Sprocket hole position	W_5	W_1	9	–0.5/+0.75
Sprocket hole diameter	D_0	D_0	4	±0.2
Abscissa to plane (straight lead)*	H	H	18.5	±3.0
Abscissa to top RGE300 - RGE600	H_1	H_1	32.2	max.
Abscissa to top RGE700*	H_1	H_1	36	max.
Overall width w/lead protrusion RGE300 - RGE600	C_1		43.2	max.
Overall width w/lead protrusion RGE700	C_1	C_1	46	max.
Overall width w/o lead protrusion	C_2		42.5	max.
Lead protrusion	L_1	l_1	1.0	max.
Protrusion of cut-out	L	L	11	max.
Protrusion beyond hold-down tape	l_2	l_2	Not specified	
Sprocket hole pitch	P_0	P_0	12.7	±0.3
Device pitch			12.7	
Pitch tolerance			20 consec.	±1
Tape thickness	t	t	0.9	max.
Tape thickness with splice*	t_1		2.0	max.
Splice sprocket hole alignment			0	±0.3
Body lateral deviation	Δh	Δh	0	±1.0
Body tape plane deviation	Δp	Δp	0	±1.3
Ordinate to adjacent component lead*	P_1	P_1	3.81	±1.0
Lead spacing*	F	F	5.08	±0.8
Reel width RGE300–RGE500	w_2	w	56	max.
Reel width RGE600–RGE700*	w_2	w	63.5	max.
Reel diameter	a	d	370	max.
Space between flanges less device*	w_1		4.75	±3.25
Arbor hole diameter	c	f	26	±12.0
Core diameter*	n	h	91	max.
Box			56/372/372	max.
Consecutive missing places			None	
Empty places per reel			0.1% max.	

*Differs from EIA specification

4

Figure 1: EIA Referenced Taped Component Dimensions

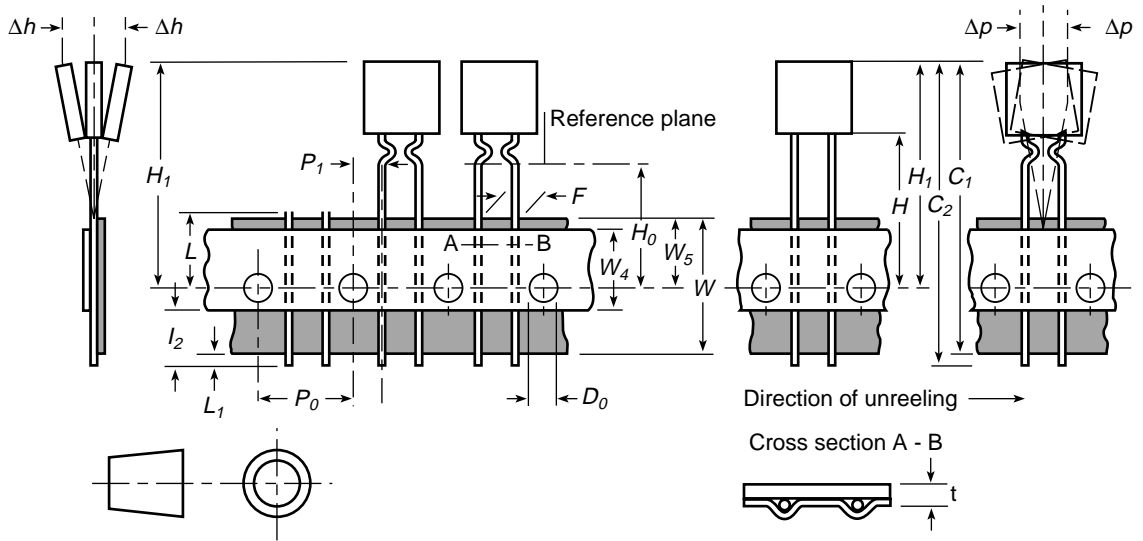

4

Figure 2: Reel Dimensions

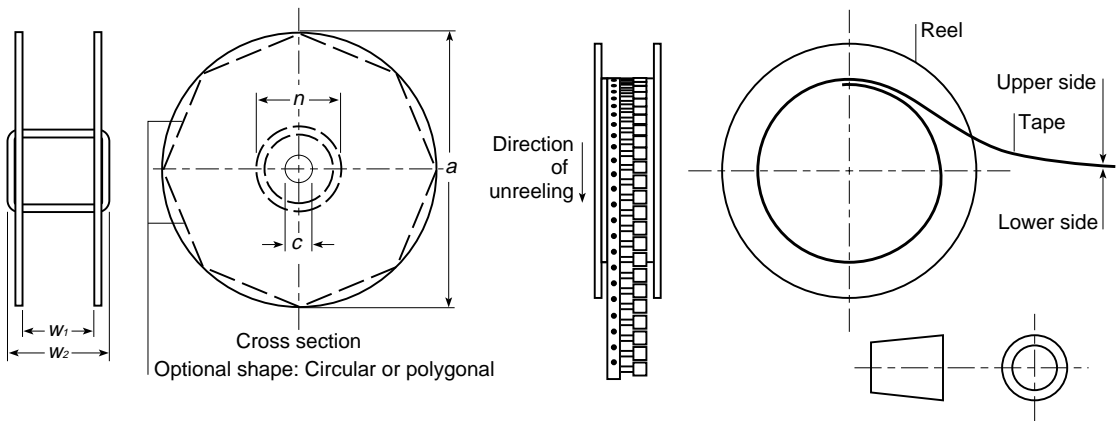

Ordering information

	Product description	Bag quantity	Tape and reel quantity	AMMO pack	Standard package
	RGE300	500			10000
	RGE300-2		2500		12500
	RGE300-AP			2000	10000
New	RGE400	500			10000
New	RGE400-2		2500		12500
New	RGE400-AP			2000	10000
	RGE500	500			10000
	RGE500-2		2000		10000
	RGE500-AP			2000	10000
New	RGE600	500			10000
New	RGE600-2		2000		10000
New	RGE600-AP			2000	10000
	RGE700	500			10000
	RGE700-2		1500		7500
	RGE700-AP			1500	7500
New	RGE800	500	*	*	10000
	RGE900	500	*	*	10000
New	RGE1000	500	*	*	5000
	RGE1100	500	*	*	5000
New	RGE1200	500	*	*	5000
New	RGE1400	500	*	*	5000

*Consult Factory

4

Part numbering system

RGE suffix

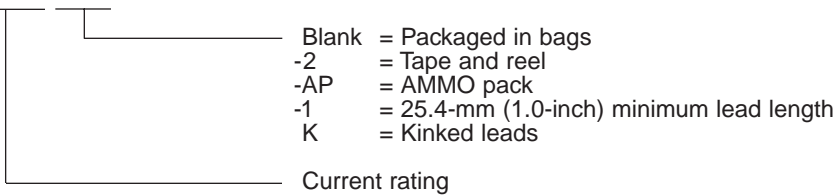

Part marking system

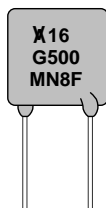

Example

X - 16
 Voltage rating
 Raychem symbol

G □ □ □ □
 Part ID
 Product family (RGE)

□ □ □ □
 Lot number/Date code (may be on the back)

Part description	Part ID
RGE300	300
New RGE400	400
RGE500	500
New RGE600	600
RGE700	700
New RGE800	800
RGE900	900
New RGE1000	1000
RGE1100	1100
New RGE1200	1200
New RGE1400	1400

WARNING:

- Operation beyond maximum ratings or improper use may result in device damage and possible electrical arcing and flame.
- These devices are intended for protection against occasional over-current or overtemperature fault conditions, and should not be used when repeated fault conditions are anticipated.
- Operation in circuits with inductive spikes can generate voltages above the rated voltage of the devices and should be evaluated for suitability.