

FEATURES

- 175° C T_J operation
- High purity, high temperature epoxy encapsulation for enhanced mechanical strength and moisture resistance
- Low forward voltage drop
- High frequency operation
- Guard ring for enhanced ruggedness and long term

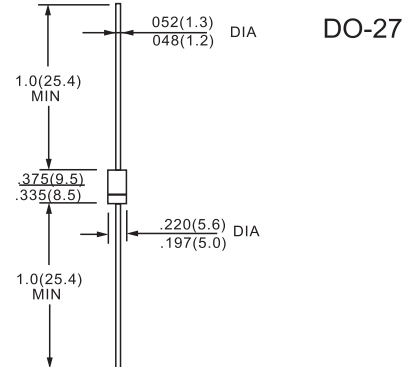

Dimensions in inches and (millimeters)

MAXIMUM RATINGS AND ELECTRICAL CHARACTERISTICS
VOLTAGE RATINGS

PARAMETER	SYMBOL	90SQ030	90SQ035	90SQ040	90SQ045	UNITS
Maximum DC reverse voltage	V _R	30	35	40	45	V
Maximum working peak reverse voltage	V _{RWM}					

ABSOLUTE MAXIMUM RATINGS

PARAMETER	SYMBOL	TEST CONDITIONS	VALUES	UNITS
Maximum average forward current See fig. 5	I _{F(AV)}	50 % duty cycle at T _C = 69 °C, rectangular waveform	9	A
Maximum peak one cycle non-repetitive surge current See fig. 7	I _{FSM}	5 μs sine or 3 μs rect. pulse	2150	
		10 ms sine or 6 ms rect. pulse	340	
Non-repetitive avalanche energy	E _{AS}	T _J = 25 °C, I _{AS} = 1.8 A, L = 7.4 mH	12	mJ
Repetitive avalanche current	I _{AR}	Current decaying linearly to zero in 1 μs Frequency limited by, T _J maximum V _A = 1.5 x V _R typical	1.8	A

ELECTRICAL SPECIFICATIONS

PARAMETER	SYMBOL	TEST CONDITIONS	VALUES	UNITS	
Maximum forward voltage drop See fig. 1	V _{FM} (1)	T _J = 25 °C	9 A	0.48	V
			18 A	0.57	
		T _J = 125 °C	9 A	0.42	
			18 A	0.52	
Maximum reverse leakage current See fig. 2	I _{RM} (1)	T _J = 25 °C	1.75	mA	
		T _J = 125 °C	70		
Maximum junction capacitance	C _T	V _R = 5 V _{DC} , (test signal range 100 kHz to 1 MHz) 25 °C	900	pF	
Typical series inductance	L _S	Measured lead to lead 5 mm from body	10.0	nH	
Maximum voltage rate of change	dV/dt	Rated V _R	10 000	V/μs	

THERMAL - MECHANICAL SPECIFICATIONS

PARAMETER	SYMBOL	TEST CONDITIONS	VALUES	UNITS
Maximum junction and storage temperature range	T _J , T _{Stg}		- 55 to 150	°C
Maximum thermal resistance, junction to lead	R _{thJL}	DC operation; see fig. 4 1/8" lead length	8.0	°C/W
Typical thermal resistance, junction to air	R _{thJA}		44	
Approximate weight			1.4	g
			0.049	oz.
Marking device		Case style DO-204AR (JEDEC)	90SQ030	
			90SQ035	
			90SQ040	
			90SQ045	

RATINGS AND CHARACTERISTIC CURVES 90SQ030 THRU 90SQ045

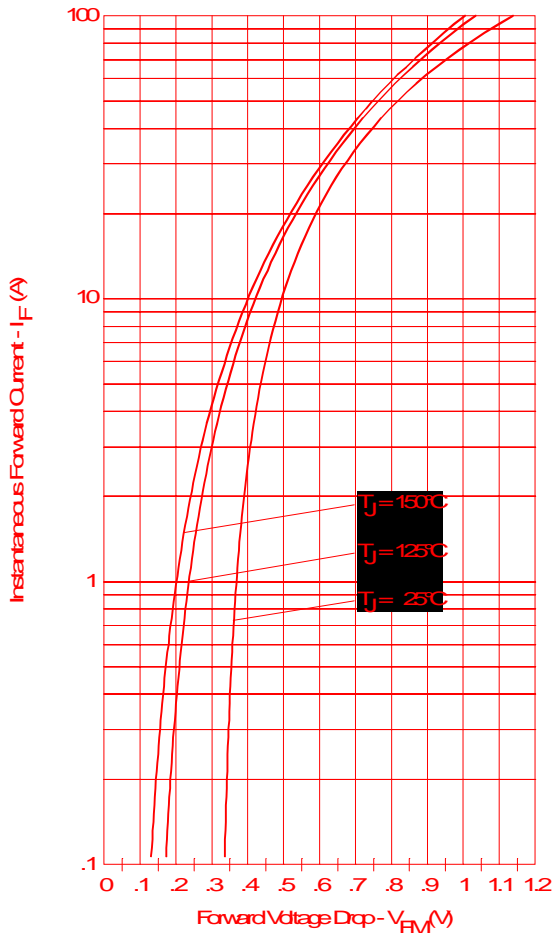

Fig. 1 - Maximum Forward Voltage Drop Characteristics

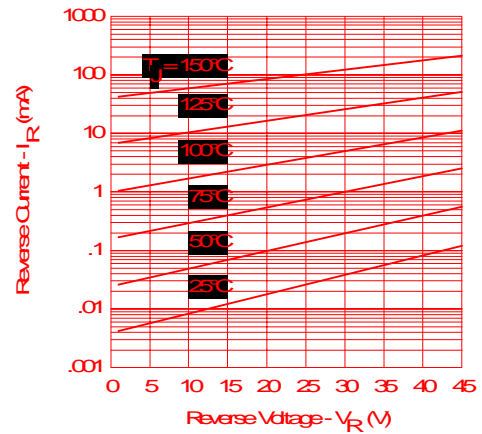

Fig. 2 - Typical Values of Reverse Current Vs. Reverse Voltage

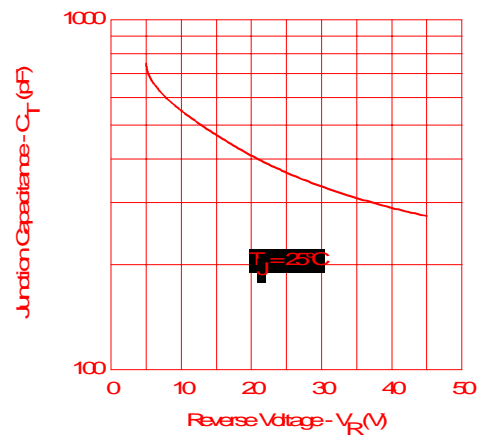

Fig. 3 - Typical Junction Capacitance Vs. Reverse Voltage

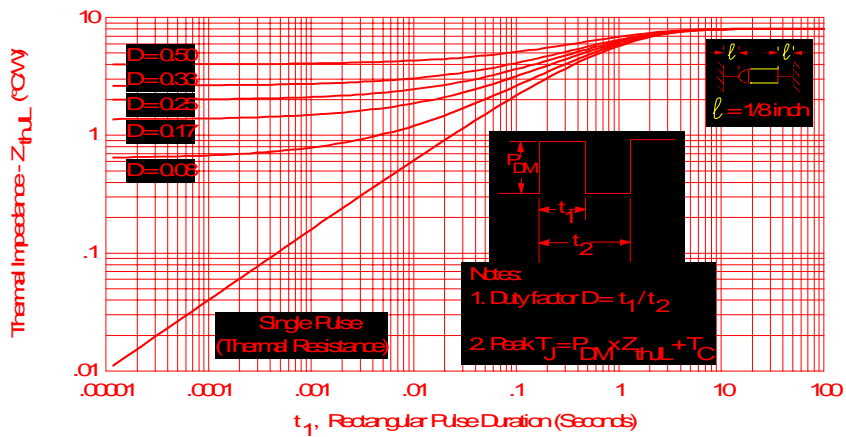

Fig. 4 - Maximum Thermal Impedance Z_{thL} Characteristics

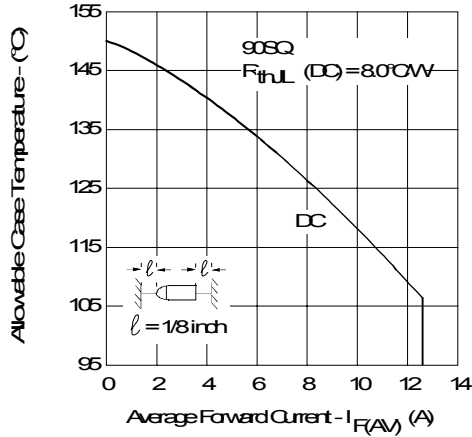

Fig. 5 - Maximum Allowable Case Temperature Vs. Average Forward Current

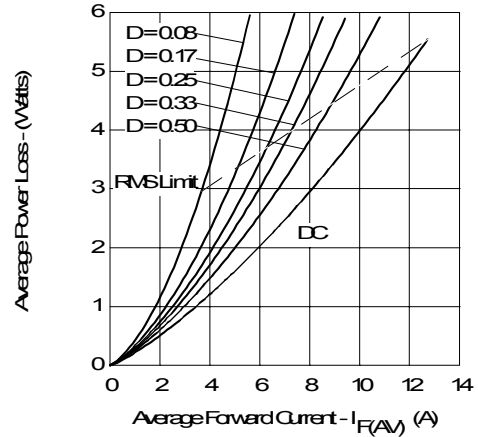

Fig. 6 - Forward Power Loss Characteristics

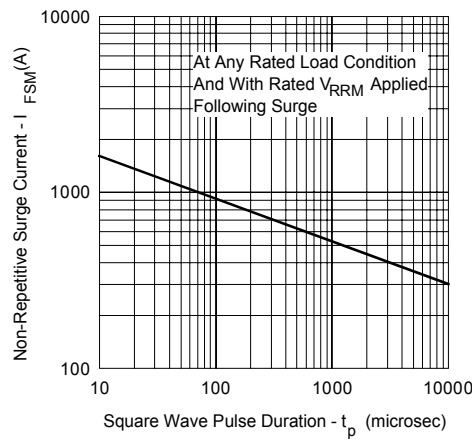

Fig. 7 - Maximum Non-Repetitive Surge Current

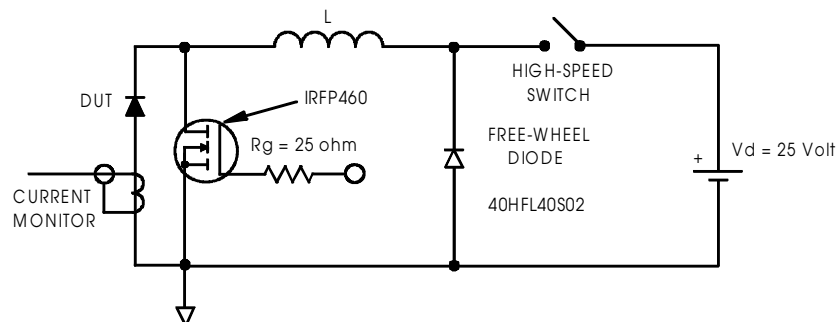

Fig. 8 - Unclamped Inductive Test Circuit