



T80-L

Alternate Action and Momentary Pushbutton Switches



SPDT



Model No.	Switching position	
L8601	on	on
L8603	on	mom
Term. Comm.	2-3	2-1

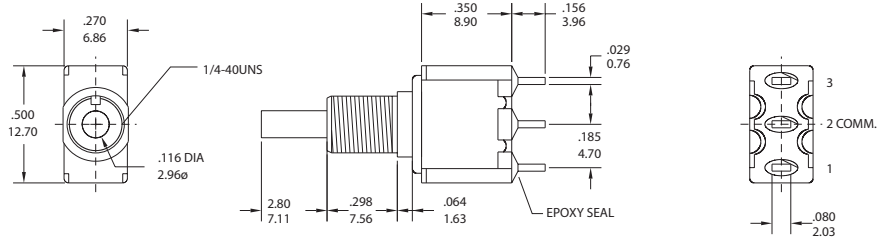
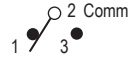

L8601-EBR-E

SPDT



Model No.	Switching position	
L8601P	on	on
L8603P	on	mom
Term. Comm.	2-3	2-1

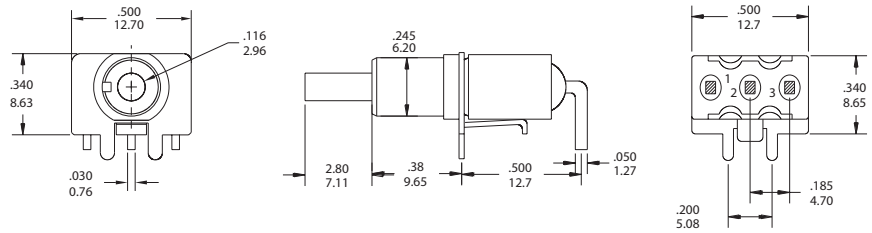

L8601P-MR-E

SPDT



Model No.	Switching position	
L8601L	on	on
L8603L	on	mom
Term. Comm.	2-3	2-1

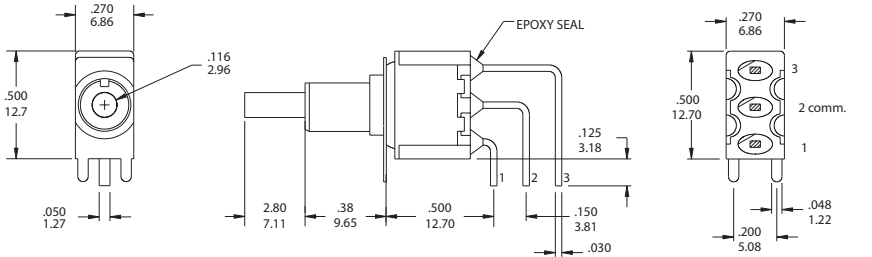

L8601L-MR-E

DPDT



Model No.	Switching position	
L8602	on	on
Term. Comm.	2-3 □ 5-6	2-1 □ 5-4

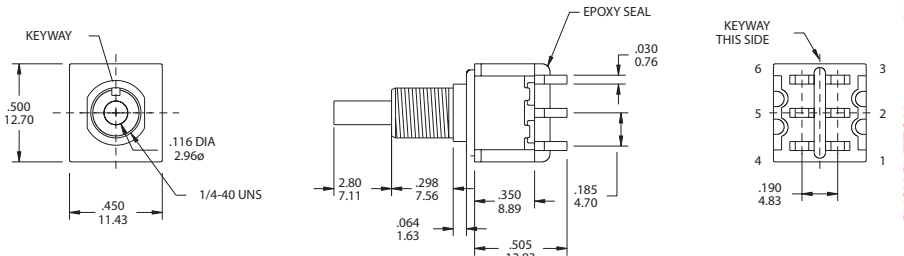

L8602-EBR-E

DPDT



Model No.	Switching position	
L8602P	on	on
Term. Comm.	2-3 □ 5-6	2-1 □ 5-4

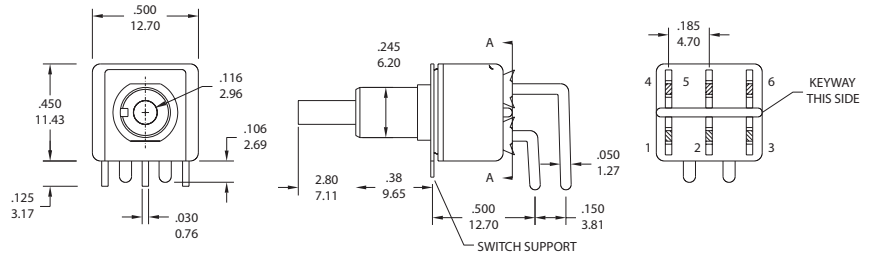

L8602P-MR-E

DPDT



Model No.	Switching position	
L8602L	on	on
Term. Comm.	2-3 □ 5-6	2-1 □ 5-4

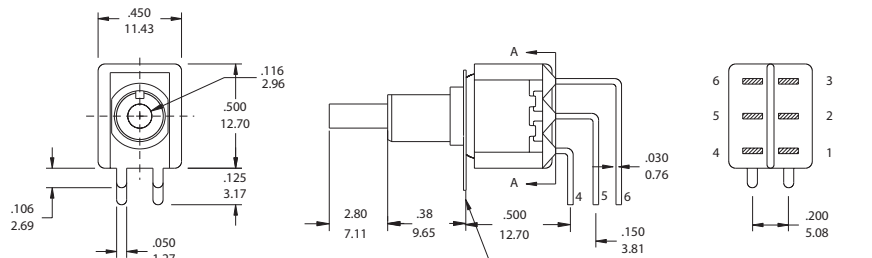

L8602L-MR-E

INDEX
TOGGLE
ROCKER
SLIDE
PUSHBUTTON
DIP
TACT



T80-L

Alternate Action and Momentary Pushbutton Switches



Cap and Actuator Option

Cap color option

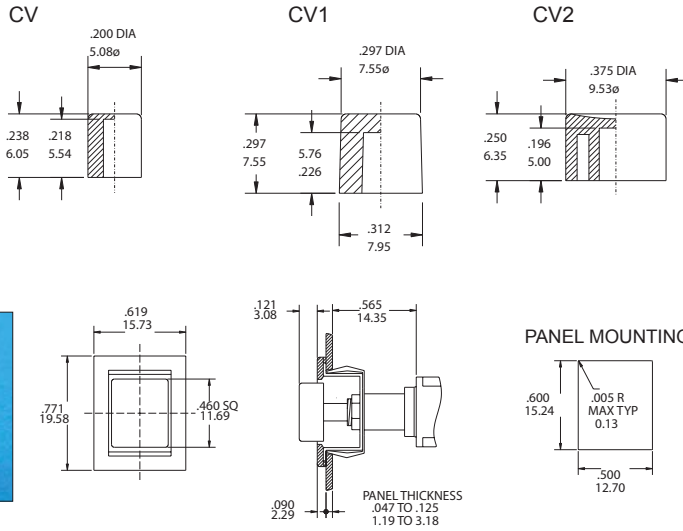

CAP & ACTUATOR OPTIONS	
1	White
2	Black(Std.)
3	Red
4	Orange
5	Yellow
6	Green
7	Blue
8	Brown
9	Gray



F22A

L860X-F22A-X-BR-E

Plunger Option

Bushing Option

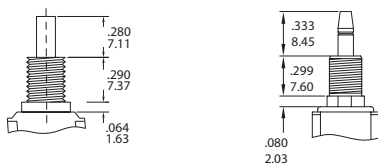

(none) STD.

M

Plunger material:
Glass filled nylon or
glass filled polyester.

Plunger material:
Brass, chrome plated.

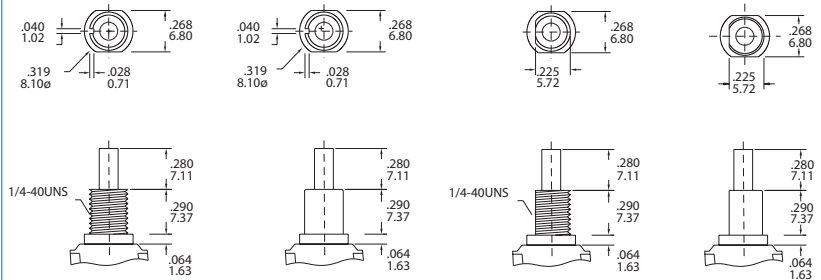

E

M

F

N

PANEL MOUNTING DIMENSION

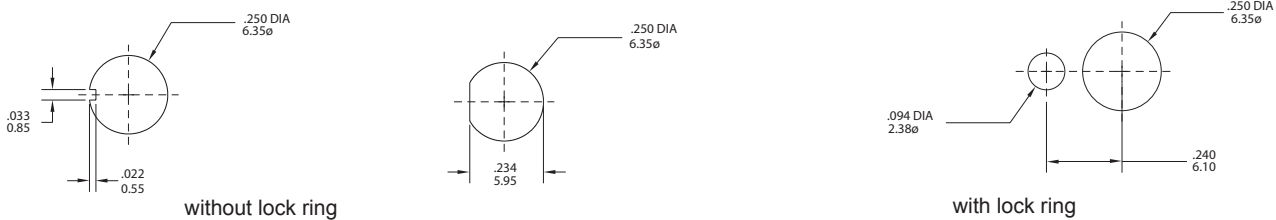

without lock ring

with lock ring

TERMINAL OPTION (ONLY FOR THE STRAIGHT TYPE L8601~L8602)

TERMINAL SEAL OPTION

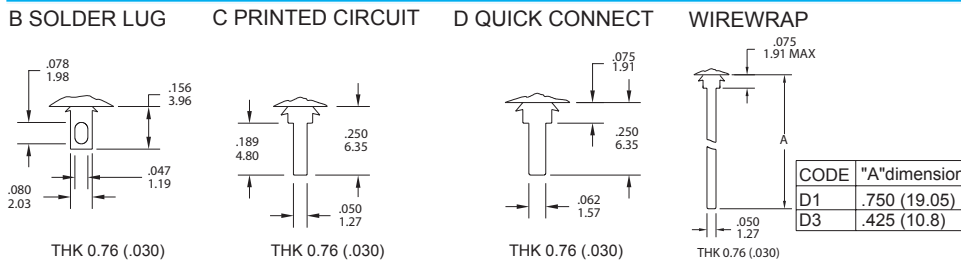

B SOLDER LUG

C PRINTED CIRCUIT

D QUICK CONNECT

WIREWRAP

THK 0.76 (.030)

THK 0.76 (.030)

THK 0.76 (.030)

THK 0.76 (.030)

CODE	"A" dimension
D1	.750 (19.05)
D3	.425 (10.8)

E TERMINAL SEAL



EPOXY SEAL

CONTACT MATERIAL OPTIONS

CODE	CONTACT MATERIAL	TERMINAL MATERIAL	RATING
Q	Silver plated	Silver plated	5A @ 125VAC or 28 VDC
R	Gold plated over nickel plated	Gold plated over nickel plated	0.4 VA MAX @ 20VAC or DC MAX
G	Gold plated over silver plated	Gold plated over silver plated	0.4 VA MAX @ 20 VAC or DC MAX or 5A @ 125VAC or 28 VDC

INDEX
TOGGLE
ROCKER
SLIDE
PUSHBUTTON
DIP
TACT



T80-L

Alternate Action and Momentary Pushbutton Switches



VERTICAL SUPPORT BRACKET OPTION

(only apply the straight type terminal . Please choose the terminal option in "c" code)

option Code	A dimension
S20/V20	.460 11.68
S25/V25	.630 16.00

V20/V25: the snap-in type

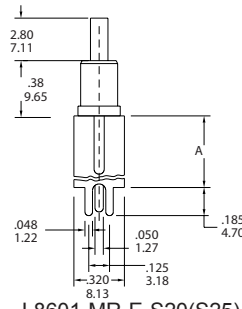
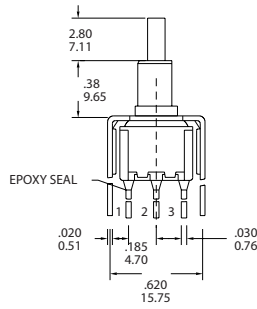

P.C. MOUNTING

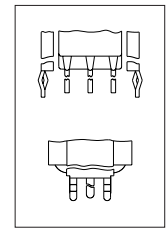
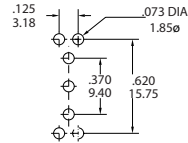

SNAP-IN
V20/ V25

L8601-MR-E-S20(S25)

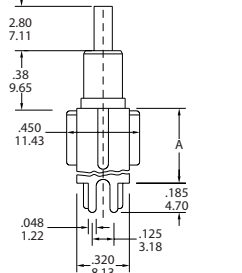
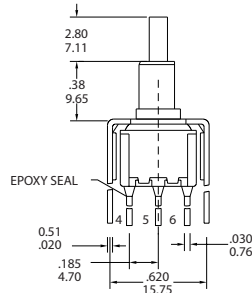

P.C. MOUNTING

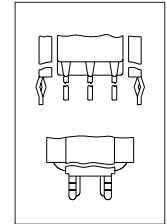
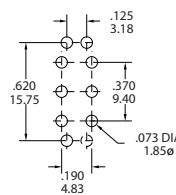

SNAP-IN
V20/ V25

L8602-MR-E-S20(S25)

option Code	A dimension
S35/V35	.460 11.68
S40/V40	.630 16.00

V35/V40 : the snap-in type

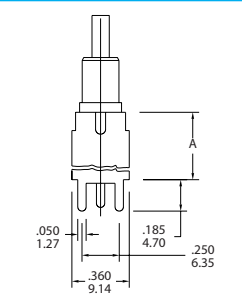
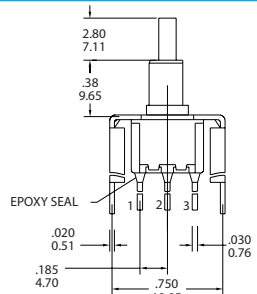

P.C. MOUNTING

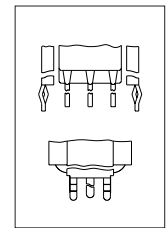
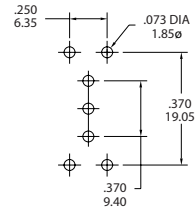

SNAP-IN
V35/ V40

L8601-MR-E-S35(S40)

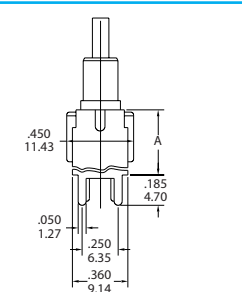
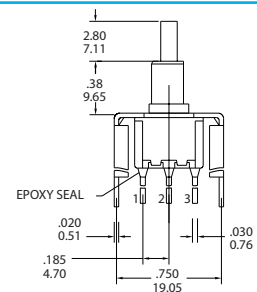

P.C. MOUNTING

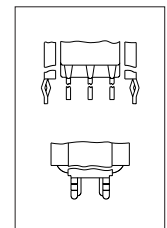
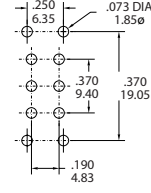

SNAP-IN
V35/ V40

L8602-MR-E-S35(S40)

The P.C.B mounting Dimensions

L8601P

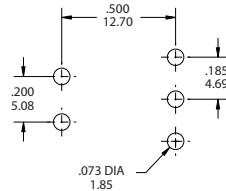

L8602P

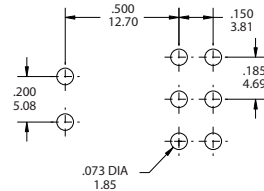

L8601L

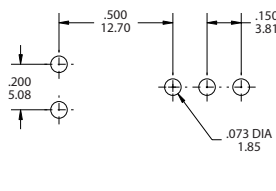

L8602L

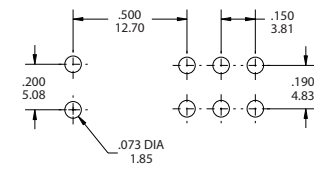

The hard ware of T80-L push button switches

STD.

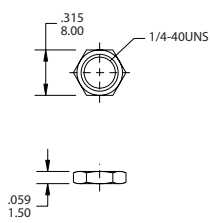

DRESS NUT

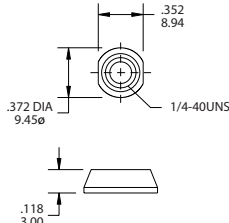

STD.

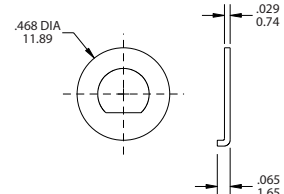
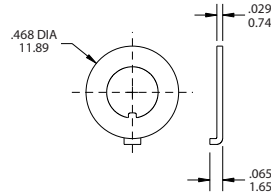
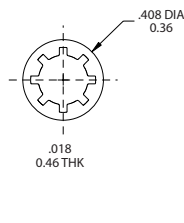

INDEX TOGGLE ROCKER SLIDE PUSHBUTTON DIP TACT